

Cross Section Drawing
AX550 Stacking Door O3X Mid Sill
Block Frame



Clearly the best.™

CAD File Scale	View	File Name	Units	Revision
NTS	Horizontal & Vertical	AX550_11601_Stack_O3X_Mid_Sill_Block	Inch	03/2022

More Technical Documents can be found at milgard.com/professionals
 Due to continual research and development, details may be changed at any time. ©2021 Milgard Mfg.

STACKING
SERIES 11601

Configuration O3X shown
 Configuration 3XO also available

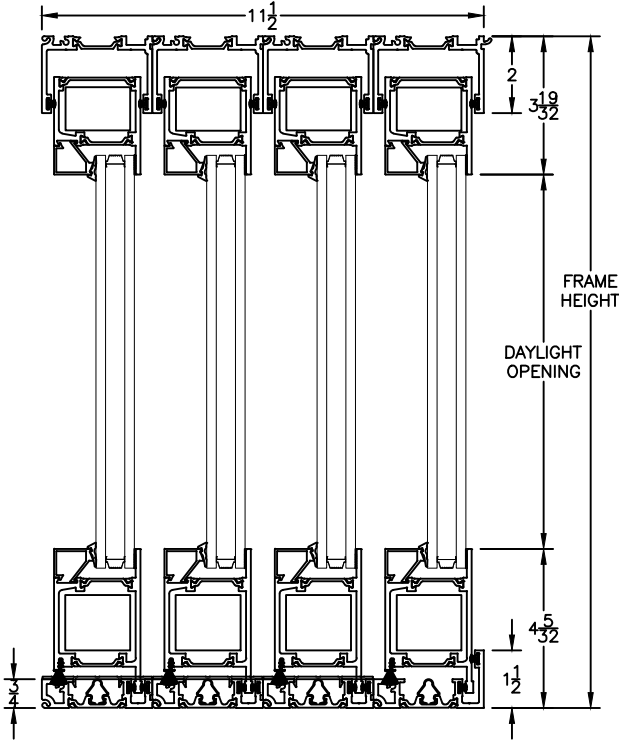

HEAD & SILL

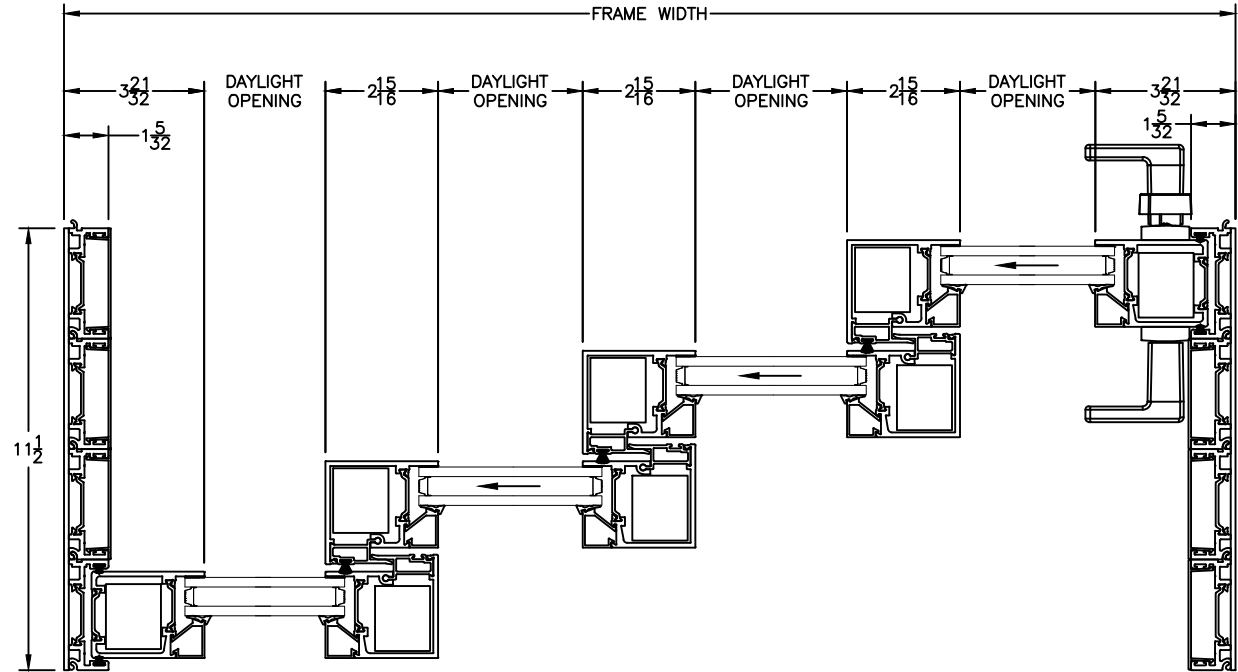

JAMBS