

Cross Section Drawing
AX550 Bi-Fold Doors 3L1R Mid Sill
Block Frame



Clearly the best.™

CAD File Scale	View	File Name	Units	Revision
NTS	Horizontal & Vertical	AX550_11621_BI_3L1R_Mid_Sill_Block	Inch	3/2022

More Technical Documents can be found at milgard.com/professionals
 Due to continual research and development, details may be changed at any time. ©2021 Milgard Mfg.

BI-FOLD
SERIES 11621

Configuration 3L1R shown
 Configuration 1L3R also available

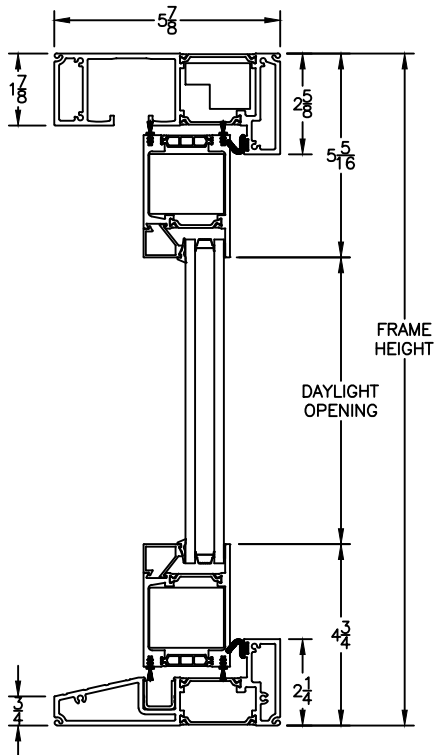

HEAD & SILL

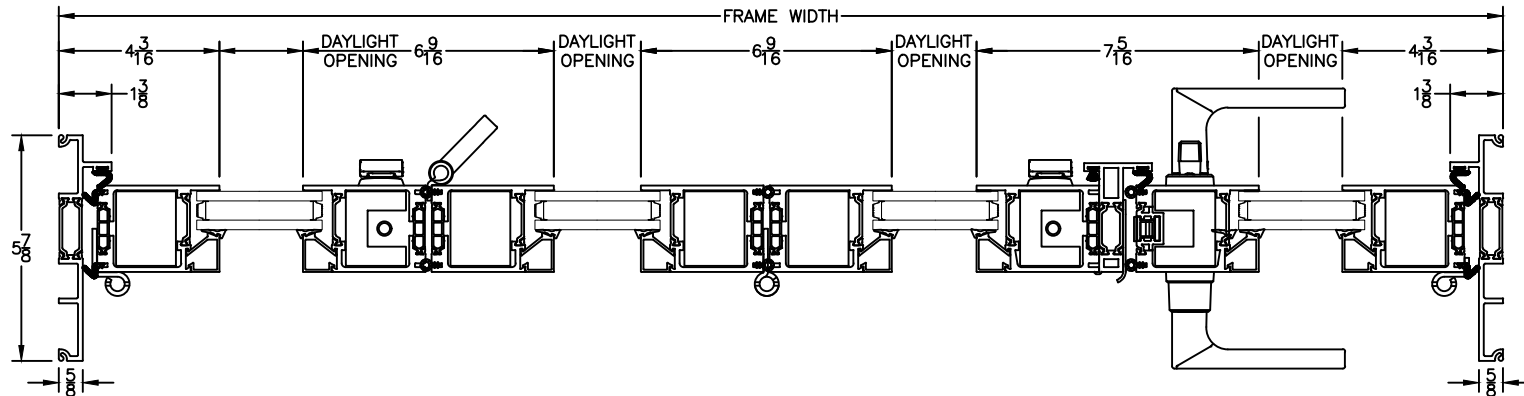

JAMBS