

# Cross Section Drawing

## AX450 Multi-Slide Stacking Door O3X Water Barrier Sill

CAD File Scale  
NTS

View  
Horizontal & Vertical

File Name  
AX450 Stacking O3X Water Barrier Sill

Units  
Inch

Revision  
01/2025

More Technical Documents can be found at [milgard.com/professionals](http://milgard.com/professionals)  
Due to continual research and development, details may be changed at any time. ©2025 Milgard Mfg.

### STACKING

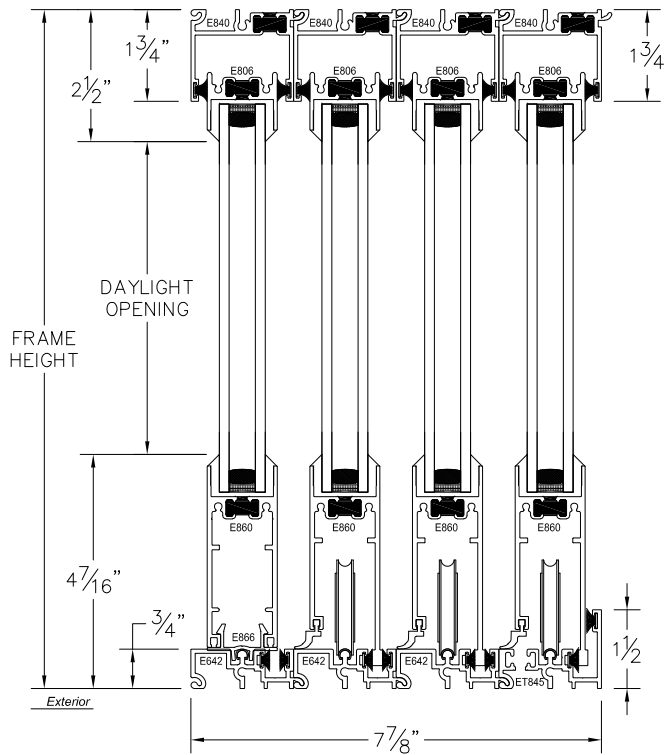

HEAD & SILL

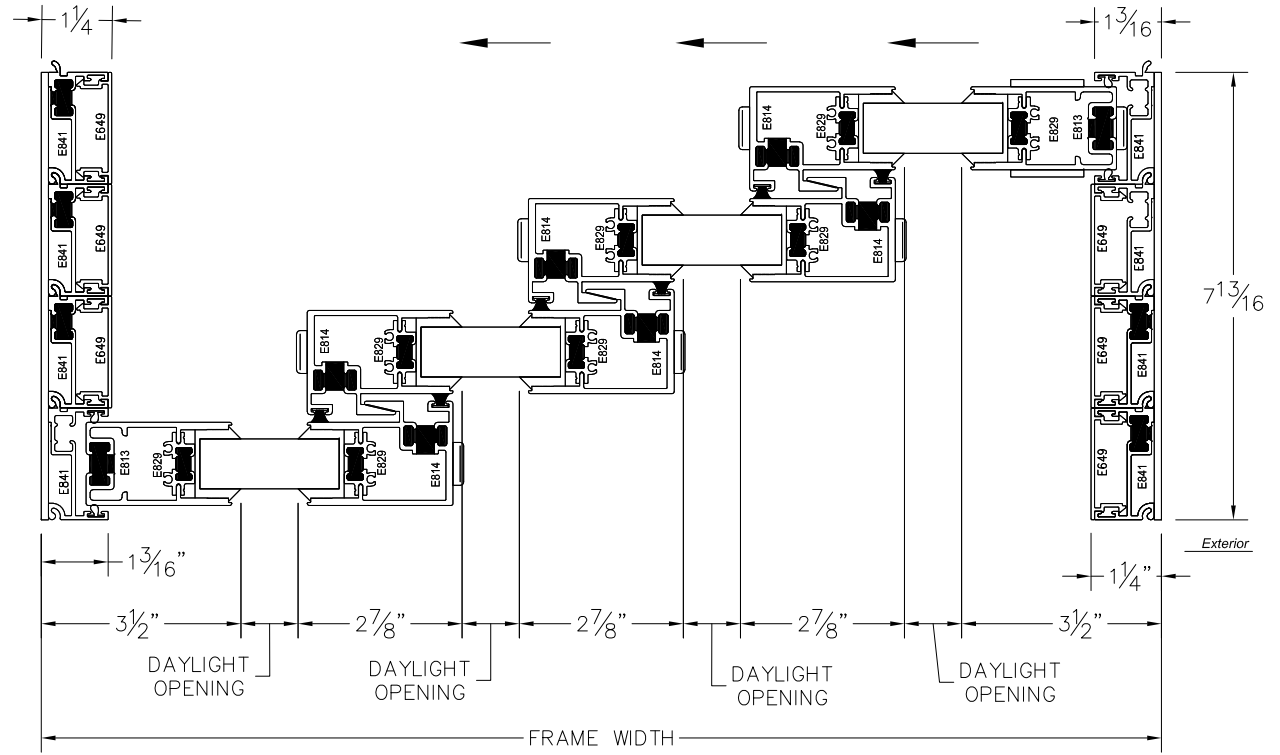

JAMBS