

Cross Section Drawing

VX450 Multi-Slide Pocket Door, 12090 P3X Water Barrier Sill



CAD File Scale
NTS

View
Horizontal & Vertical

File Name
AX450 Pocket P3X WATER BARRIER SILL 12090

Units
Inch

Revision
03/2025

More Technical Documents can be found at milgard.com/professionals
Due to continual research and development, details may be changed at any time. ©2025 Milgard Mfg.

POCKET

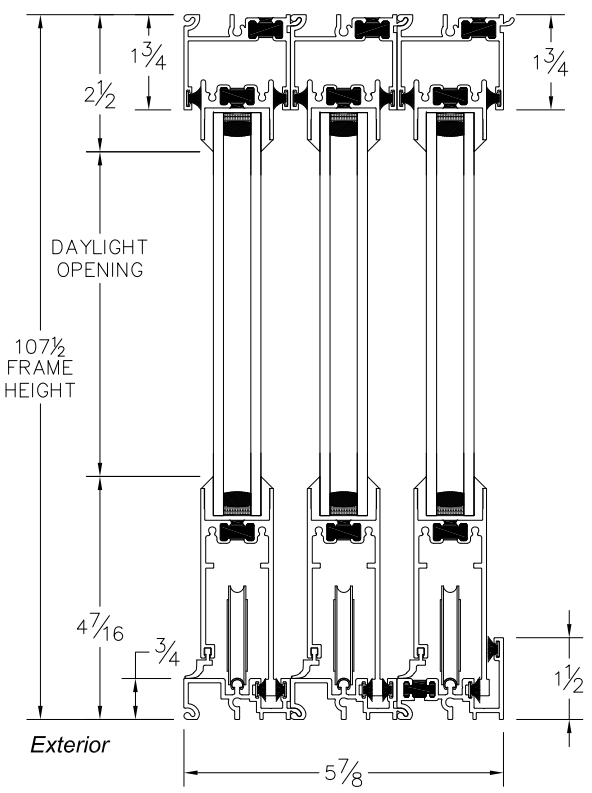

HEAD & SILL

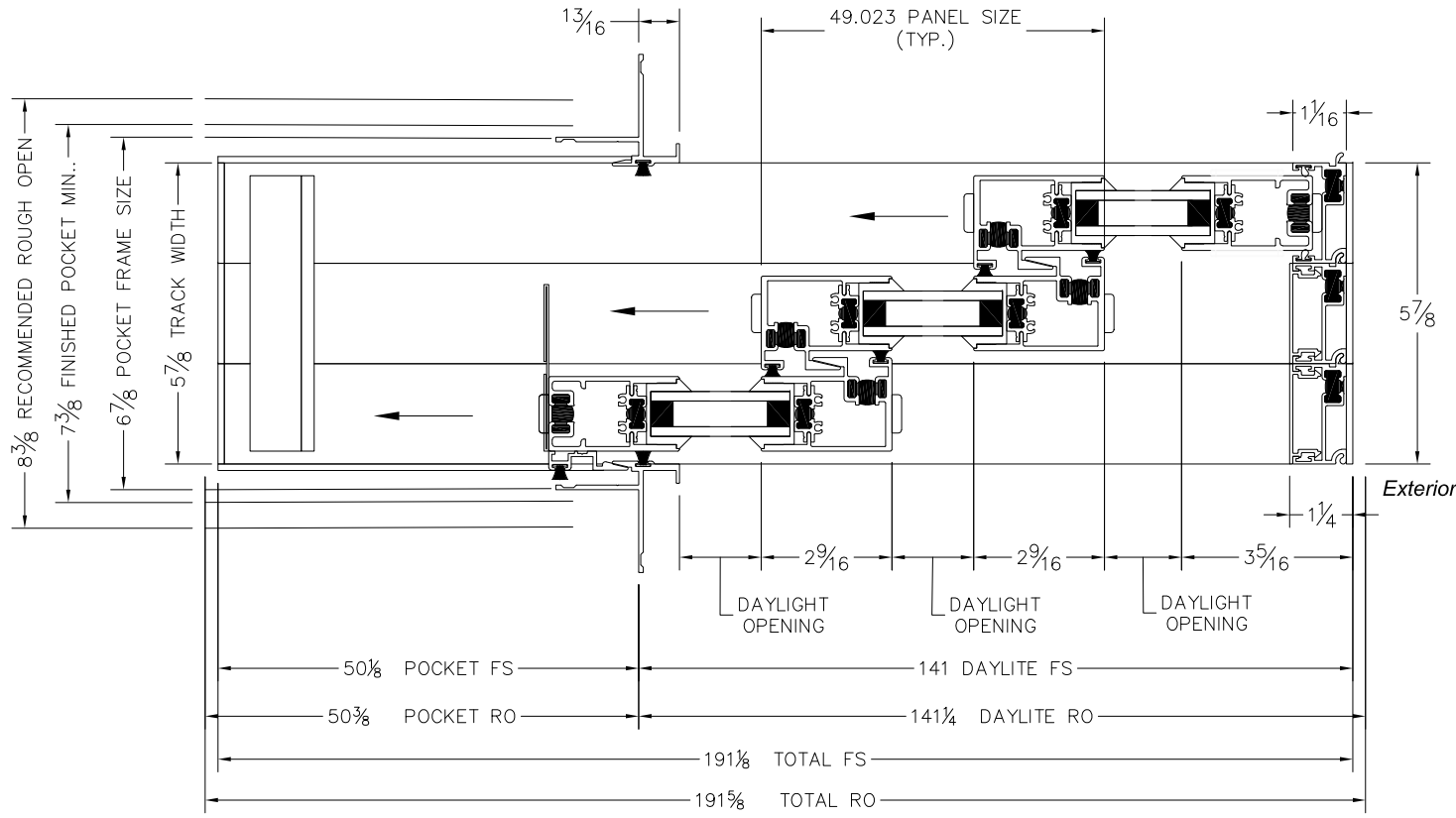

JAMBS